

inédit

LIGHTING

Cirio Chandelier

Antoni Arola. 2015
Pendant lamps



Porcelain



Glass



Brass

Chandelier S



A

Chandelier M



B

Chandelier L



C



The Cirio Chandelier pools a large body of light onto a focal axis that stands out hugely from its surrounding area. Its dense array of concentric rings, from which twenty, thirty and even forty light sources may be hung thanks to the enlargeable diameter of the structure, gives off a warm, powerful light with a major visual impact.

The shade, beautifully designed, is reminiscent of a candle for its shape, texture and the warmth of its light. The varying shades combined with LED capsules can be used to create different atmospheres: from the porcelain of Sargadelos (Galicia, Spain) that creates candle-like warmth, to translucent opal glass, and the opaque elegance of brass.

Cirio is a system that provides customisable solutions for vertical lighting by combining structures, shades and light textures. The pendant lamp can be used alone or arranged in rows or clusters to illuminate larger areas, in forms such as the Chandelier, Cascada, Circular, Lineal, Oval or Múltiple. A perfect combination of repeated elements. The fusion of technology and tradition; innovation through craftsmanship. A truly unique lighting experience.

General description:

Capsule with LED module, translucent white diffuser and heat sink with black matte finish.

3 lampshade options: white porcelain, white opal glass and polished brass.

Black aluminium circular structure:

(A) \varnothing 100 cm / 39.4" for 20 lampshades

(B) \varnothing 130cm / 51.2" for 30 lampshades

(C) \varnothing 160 cm / 63" for 40 lampshades

Adjustable black metallic circular canopy + equipment.

2 hanging system options: direct cable to ceiling plate or direct cable to ceiling.

Suitable for Junction Box (UL market).

Electric cable length: 5 m / 196.8"

Approximate weight (unpacked):

(A) Chandelier S: 20 Kg / 44 lb

(B) Chandelier M: 30 Kg / 66 lb

(C) Chandelier L: 40 Kg / 88 lb

Lampshades:

Porcelain: 0,5 kg / 1.1 lb

Glass: 0,6 kg / 1.3 lb

Brass: 0,3 Kg / 0.7 lb

inédit

LIGHTING

Cirio Chandelier

Antoni Arola. 2015
Pendant lamps

Technical information:

Light source included (dimmable):
LED module

Rated input wattage (LED capsule): 5,7 W
Operating current: 530 mA
Colour Temp.: 2.700 K
CRI: 90
Lifetime: 40.000 h

(A) 20 light sources
Rated input wattage: 114 W
Luminous flux:
Porcelain 3.280 lm
Glass 11.180 lm
Brass 3.520 lm

(B) 30 light sources
Rated input wattage: 171 W
Luminous flux:
Porcelain 4.920 lm
Glass 16.770 lm
Brass 5.280 lm

(C) 40 light sources
Rated input wattage: 228 W
Luminous flux:
Porcelain 6.560 lm
Glass 22.360 lm
Brass 7.040 lm

Built-in adjustable LED.
Lamp suitable for dimming 1-10V. / DALI. Not included external
dimmer switch 1-10V. / DALI
Energy efficiency class (E.E.C): A++...A.
Lamp suitable only for indoor use.

Input voltage: 120 ~ 277 Vac.
(50 Hz / 60 Hz). According to destination.

White porcelain lampshade

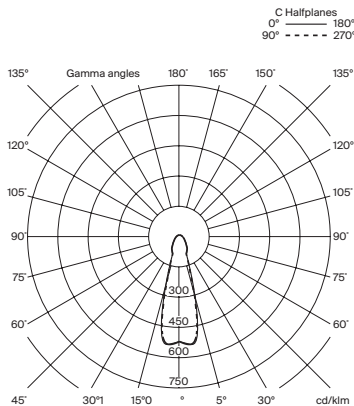

White opal glass lampshade

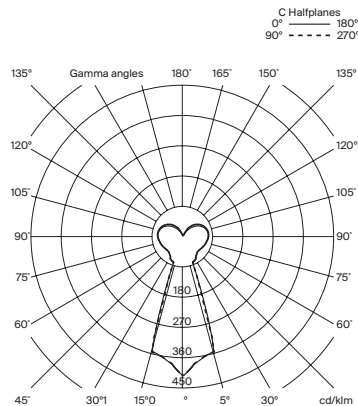

Brass lampshade

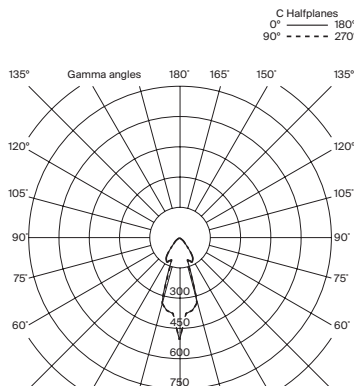

inédit

LIGHTING

Cirio Chandelier

Antoni Arola. 2015
Pendant lamps

Regulations:

CE
UNE-EN 60598
UNE-EN 55015
UNE-EN 62031
UNE-EN 61000-3-2
UNE-EN 60529
UNE-EN 61347-2-13

UL

Dry and damp location
UL-1598
UL-8750
E-336377

Maintenance:

Clean with a smooth cloth. Do not use ammonia, solvents or abrasive cleaning products.

Others:

The lamp is delivered in different packages.
The assembly instructions are delivered with the product.

Model A: Cirio Chandelier S

Direct cable to canopy

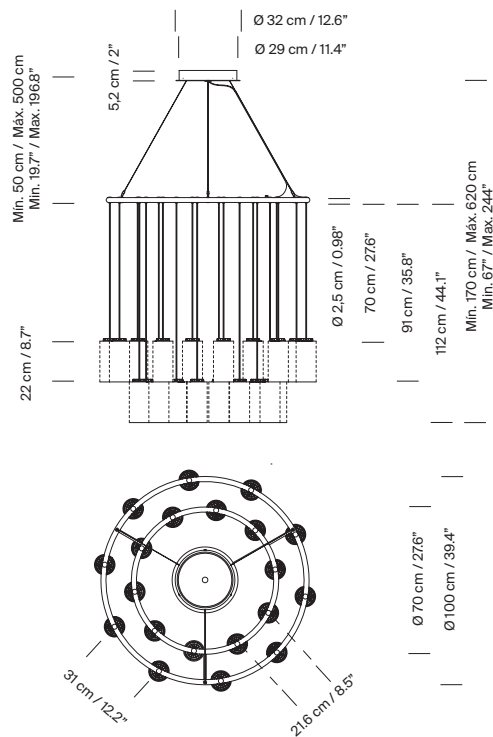

Direct cable to ceiling

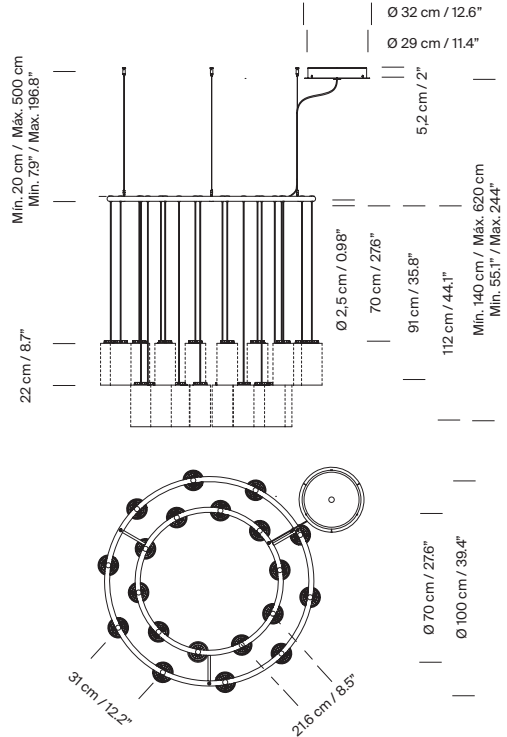

inédit

LIGHTING

Cirio Chandelier

Antoni Arola. 2015
Pendant lamps

Model B: Cirio Chandelier M

Direct cable to canopy

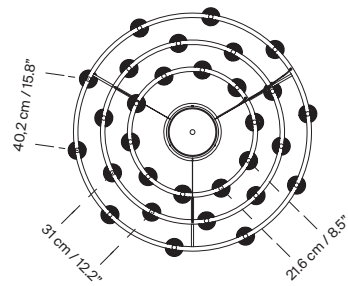
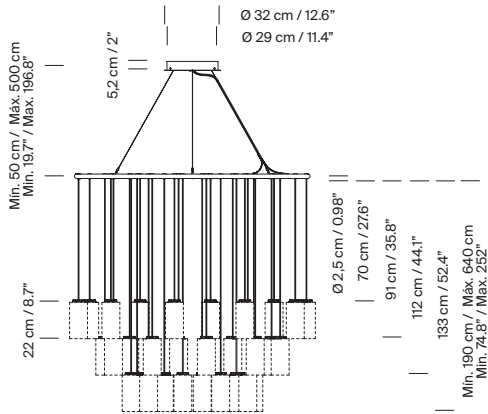

Direct cable to ceiling

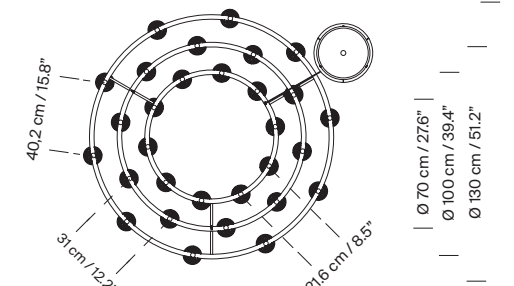
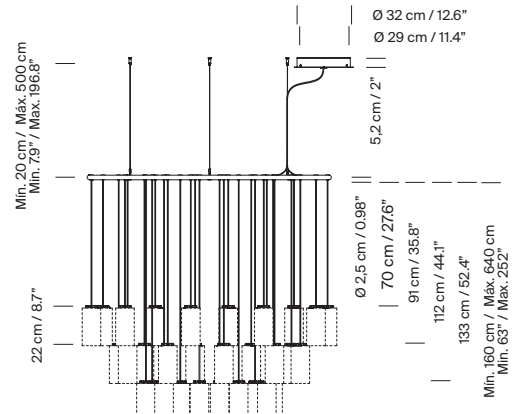

inédit

LIGHTING

Cirio Chandelier

Antoni Arola. 2015
Pendant lamps

Model C: Cirio Chandelier L

Direct cable to canopy

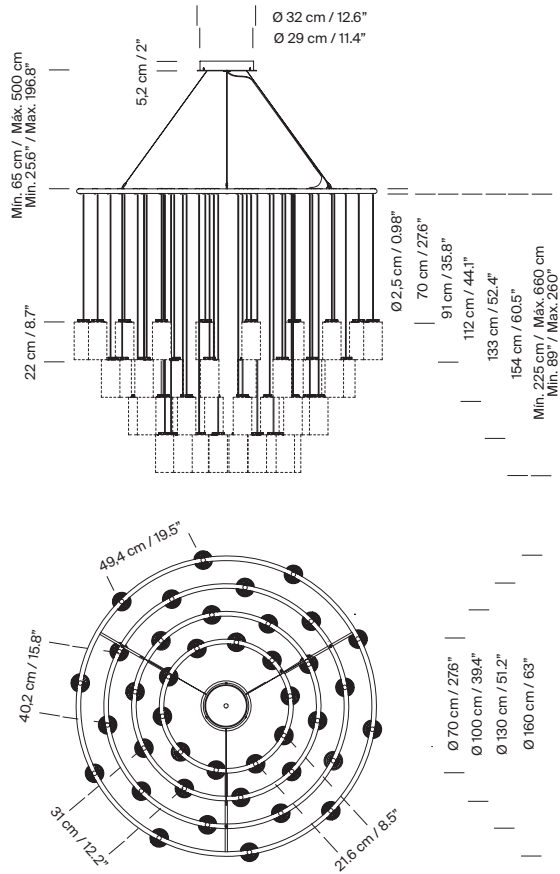

inédit

LIGHTING

Cirio Chandelier

Antoni Arola. 2015
Pendant lamps

Model C: Cirio Chandelier L

Direct cable to ceiling

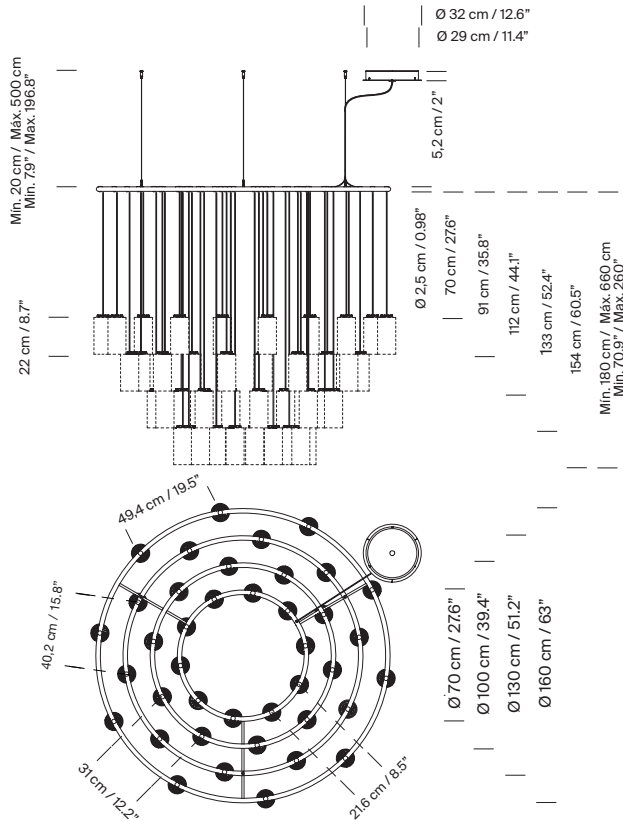

Model: Lampshades

White porcelain

White opal glass

Brass

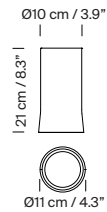
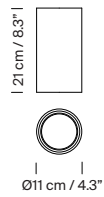
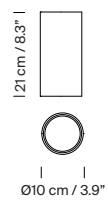

Collection:

Pendant lamps



Cirio Simple



Cirio Múltiple



Cirio Cascada



Cirio Circular



Cirio Lineal



Cirio Chandelier