



GRID GLOBE

DESIGNED BY GLENN MARYS

tossB

inédit

LIGHTING

INEDIT Lighting Studio 25, rue de Cléry 75002 PARIS
T. 33 (0)1 47 00 76 76 contact@inedit-lighting.com www.inedit-lighting.com

GRID ARM 1 WITH 1 GLOBE

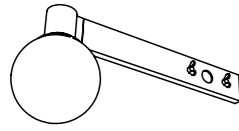

LAMP TYPE	LED
COLOUR TEMP.	2700K
WATTAGE	4W
VOLTAGE	350mA
LUMEN	400
GEAR	NOT INCLUDED
CLASS	2

ORDER CODE

BLACK ANODIZED	T108SP1DZL
WHITE PAINTED	T108SP1DWL

GRID ARM 2 WITH 1 GLOBE

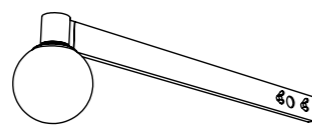

LAMP TYPE	LED
COLOUR TEMP.	2700K
WATTAGE	4W
VOLTAGE	350mA
LUMEN	400
GEAR	NOT INCLUDED
CLASS	2

ORDER CODE

BLACK ANODIZED	T108SP2DZL
WHITE PAINTED	T108SP2DWL

GRID ARM 3 WITH 1 GLOBE

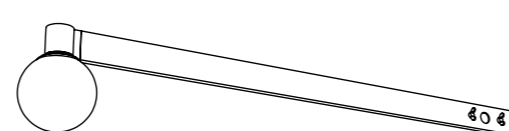

LAMP TYPE	LED
COLOUR TEMP.	2700K
WATTAGE	4W
VOLTAGE	350mA
LUMEN	400
GEAR	NOT INCLUDED
CLASS	2

ORDER CODE

BLACK ANODIZED	T108SP3DZL
WHITE PAINTED	T108SP3DWL

GRID CONNECTION PIECE 50CM

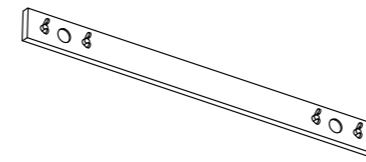

ORDER CODE

BLACK ANODIZED	T108P7DZL
WHITE PAINTED	T108P7DWL

GRID CONNECTION PIECE 75CM

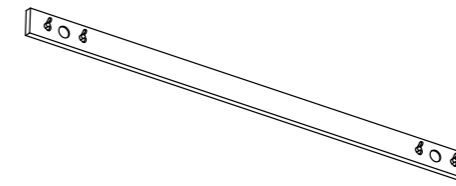

ORDER CODE

BLACK ANODIZED	T108P8DZL
WHITE PAINTED	T108P8DWL

GRID CONNECTION PIECE 100CM

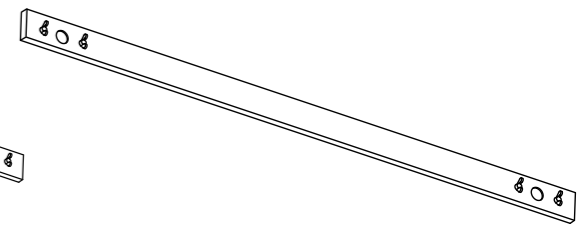

ORDER CODE

BLACK ANODIZED	T108P9DZL
WHITE PAINTED	T108P9DWL

GRID ARM 1 WITH 2 GLOBES

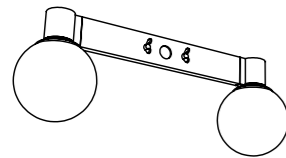

LAMP TYPE	LED
COLOUR TEMP.	2700K
WATTAGE	2x4W
VOLTAGE	350mA
LUMEN	2x400
GEAR	NOT INCLUDED
CLASS	2

ORDER CODE

BLACK ANODIZED	T108SP4DZL
WHITE PAINTED	T108SP4DWL

GRID ARM 2 WITH 2 GLOBES

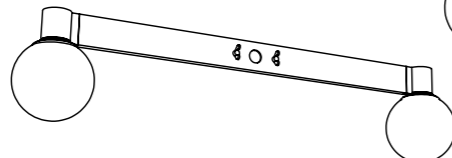

LAMP TYPE	LED
COLOUR TEMP.	2700K
WATTAGE	2x4W
VOLTAGE	350mA
LUMEN	2x400
GEAR	NOT INCLUDED
CLASS	2

ORDER CODE

BLACK ANODIZED	T108SP5DZL
WHITE PAINTED	T108SP5DWL

GRID ARM 3 WITH 2 GLOBES

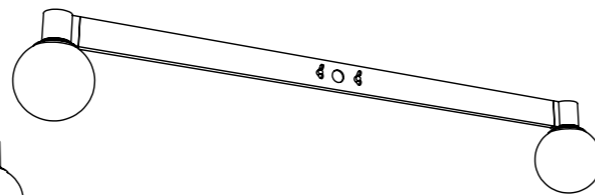

LAMP TYPE	LED
COLOUR TEMP.	2700K
WATTAGE	2x4W
VOLTAGE	350mA
LUMEN	2x400
GEAR	NOT INCLUDED
CLASS	2

ORDER CODE

BLACK ANODIZED	T108SP6DZL
WHITE PAINTED	T108SP6DWL

GRID ARM BASE WITH DRIVER

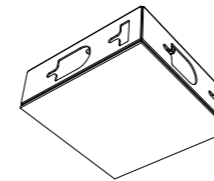

LAMP TYPE	LED
GEAR	INCLUDED (TRIAC)
WATTAGE	MAX. 4 SPOTS 4W
CLASS	1

ORDER CODE

BLACK ANODIZED	T108C1DZL
WHITE PAINTED	T108C1DWL

ARMS 1 GLOBE

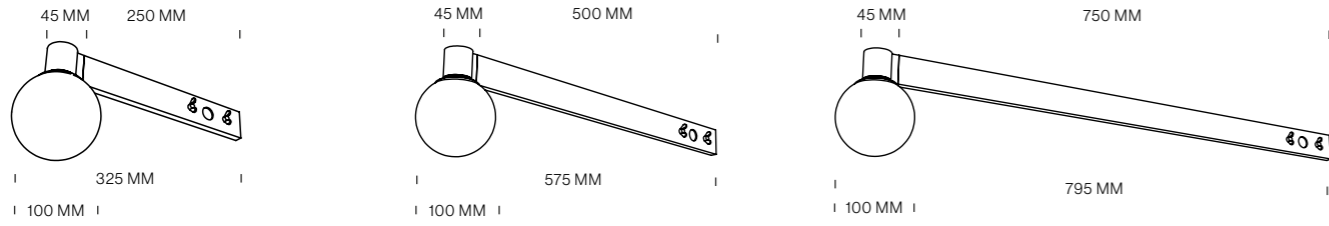

ARMS 2 GLOBES

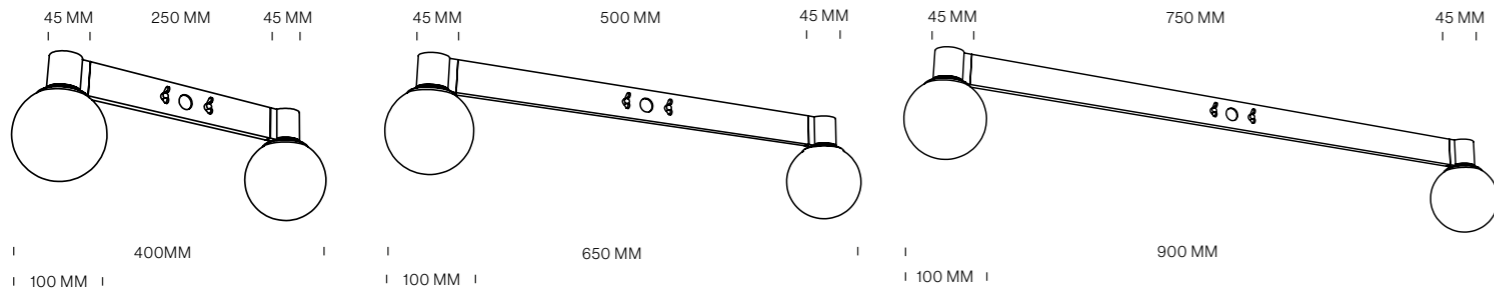

CONNECTION PIECES

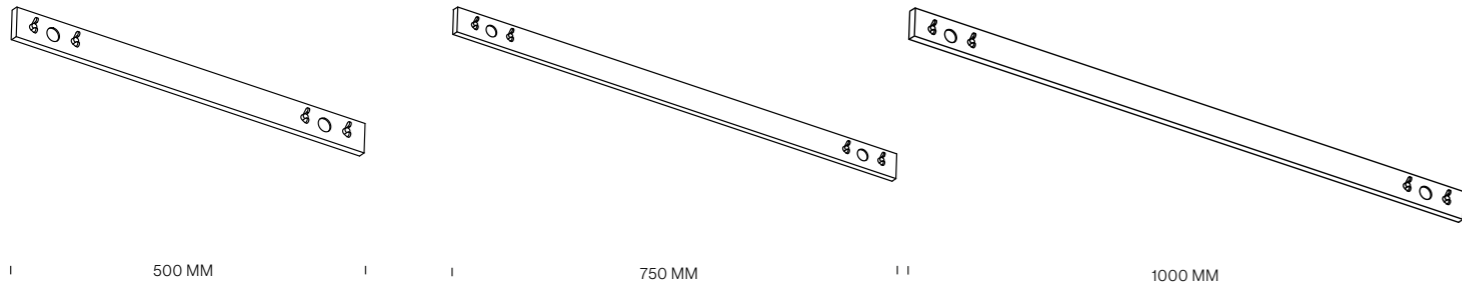

BASE WITH DRIVER

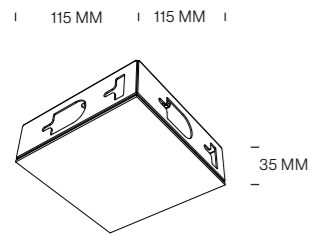

EXAMPLES - HOW TO ORDER

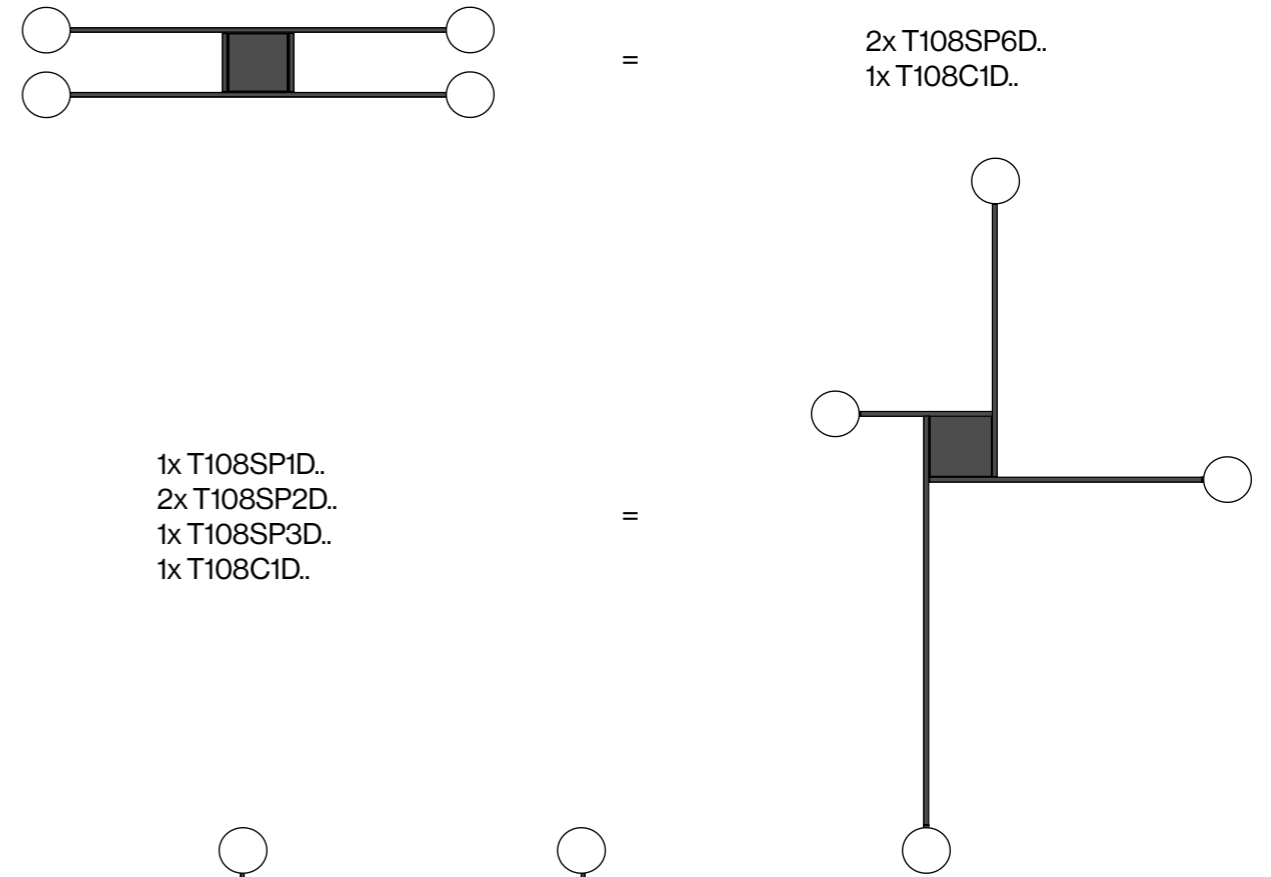

1x T108SP1D..
2x T108SP2D..
1x T108SP3D..
1x T108C1D..

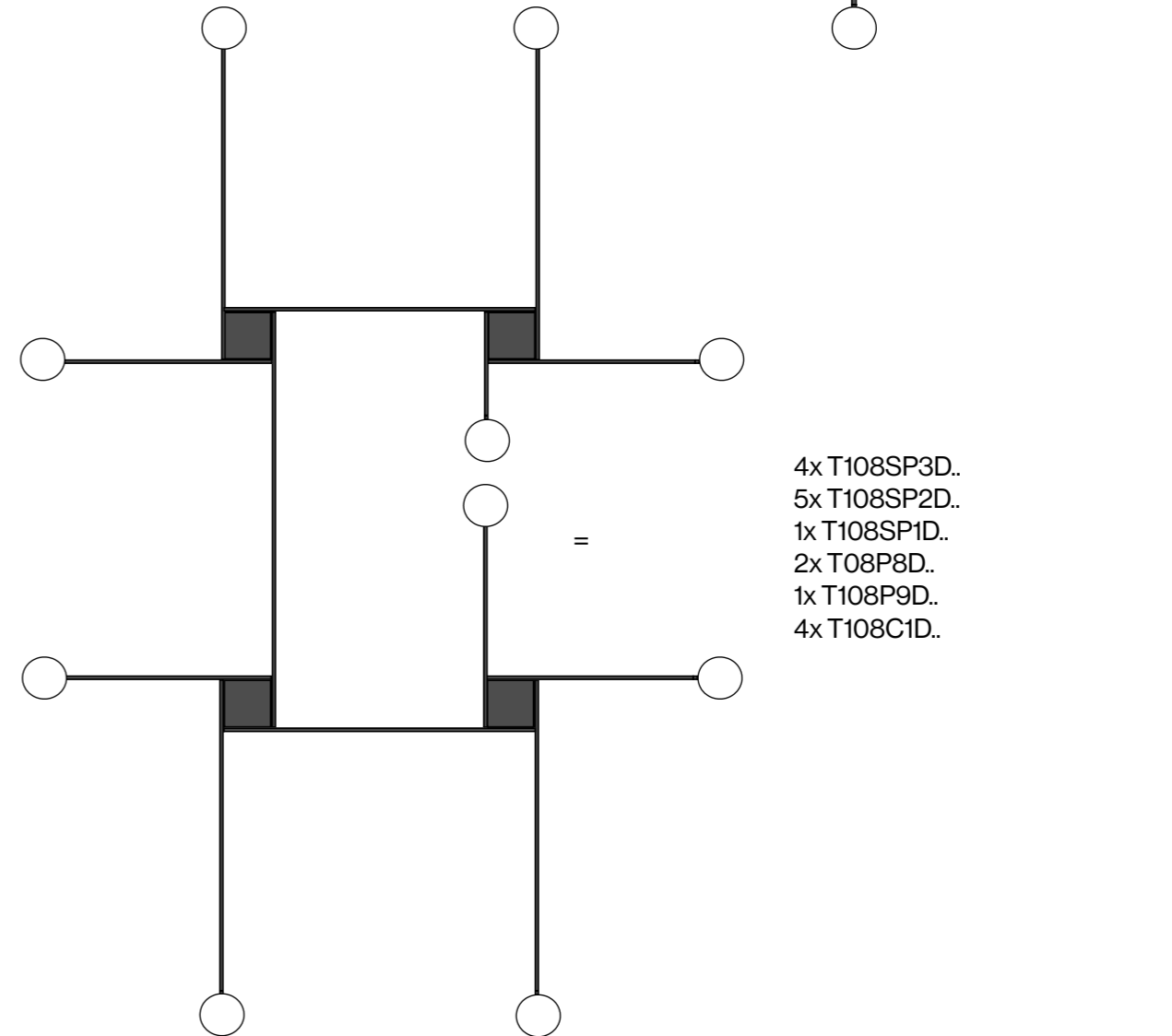



GRID

DESIGNED BY GLENN MARYS

tossB

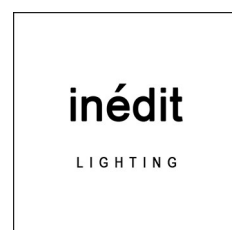

INEDIT Lighting Studio 25, rue de Cléry 75002 PARIS
T. 33 (0)1 47 00 76 76 contact@inedit-lighting.com www.inedit-lighting.com

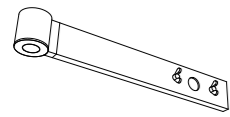
GRID ARM 1 WITH 1 SPOT

LAMP TYPE	LED
COLOUR TEMP.	2700K
WATTAGE	4W
VOLTAGE	350mA
LUMEN	400
GEAR	NOT INCLUDED
CLASS	2

ORDER CODE

BLACK ANODIZED	T108P1DZL
WHITE PAINTED	T108P1DWL

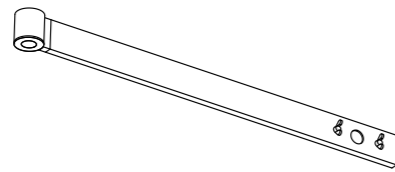
GRID ARM 2 WITH 1 SPOT

LAMP TYPE	LED
COLOUR TEMP.	2700K
WATTAGE	4W
VOLTAGE	350mA
LUMEN	400
GEAR	NOT INCLUDED
CLASS	2

ORDER CODE

BLACK ANODIZED	T108P2DZL
WHITE PAINTED	T108P2DWL

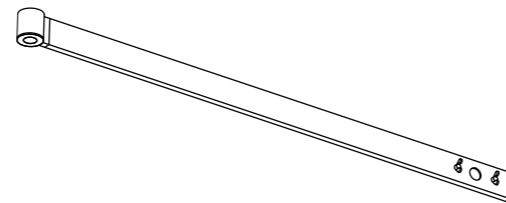
GRID ARM 3 WITH 1 SPOT

LAMP TYPE	LED
COLOUR TEMP.	2700K
WATTAGE	4W
VOLTAGE	350mA
LUMEN	400
GEAR	NOT INCLUDED
CLASS	2

ORDER CODE

BLACK ANODIZED	T108P3DZL
WHITE PAINTED	T108P3DWL

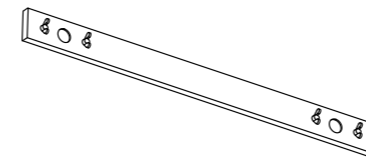
GRID CONNECTION PIECE 50CM**ORDER CODE**

BLACK ANODIZED	T108P7DZL
WHITE PAINTED	T108P7DWL

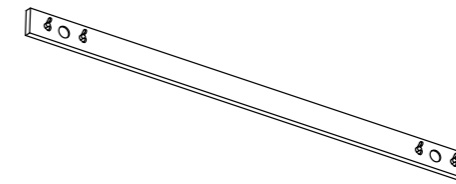
GRID CONNECTION PIECE 75CM**ORDER CODE**

BLACK ANODIZED	T108P8DZL
WHITE PAINTED	T108P8DWL

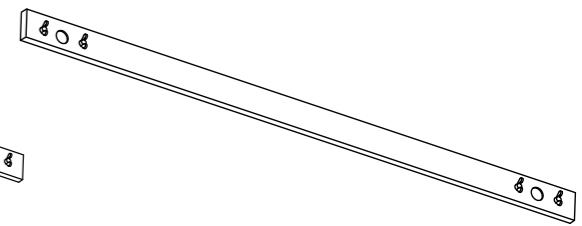
GRID CONNECTION PIECE 100CM**ORDER CODE**

BLACK ANODIZED	T108P9DZL
WHITE PAINTED	T108P9DWL

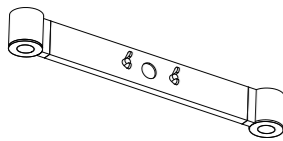
GRID ARM 1 WITH 2 SPOTS

LAMP TYPE	LED
COLOUR TEMP.	2700K
WATTAGE	2x4W
VOLTAGE	350mA
LUMEN	2x400
GEAR	NOT INCLUDED
CLASS	2

ORDER CODE

BLACK ANODIZED	T108P4DZL
WHITE PAINTED	T108P4DWL

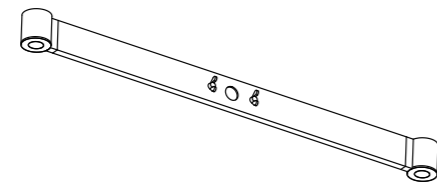
GRID ARM 2 WITH 2 SPOTS

LAMP TYPE	LED
COLOUR TEMP.	2700K
WATTAGE	2x4W
VOLTAGE	350mA
LUMEN	2x400
GEAR	NOT INCLUDED
CLASS	2

ORDER CODE

BLACK ANODIZED	T108P5DZL
WHITE PAINTED	T108P5DWL

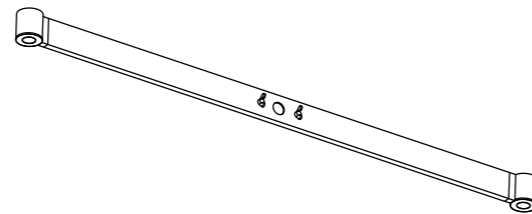
GRID ARM 3 WITH 2 SPOTS

LAMP TYPE	LED
COLOUR TEMP.	2700K
WATTAGE	2x4W
VOLTAGE	350mA
LUMEN	2x400
GEAR	NOT INCLUDED
CLASS	2

ORDER CODE

BLACK ANODIZED	T108P6DZL
WHITE PAINTED	T108P6DWL

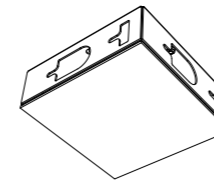
GRID BASE WITH DRIVER

LAMP TYPE	LED
GEAR	INCLUDED (TRIAC)
WATTAGE	MAX. 4 SPOTS 4W
CLASS	1

ORDER CODE

BLACK ANODIZED	T108C1DZL
WHITE PAINTED	T108C1DWL

ARMS 1 SPOT

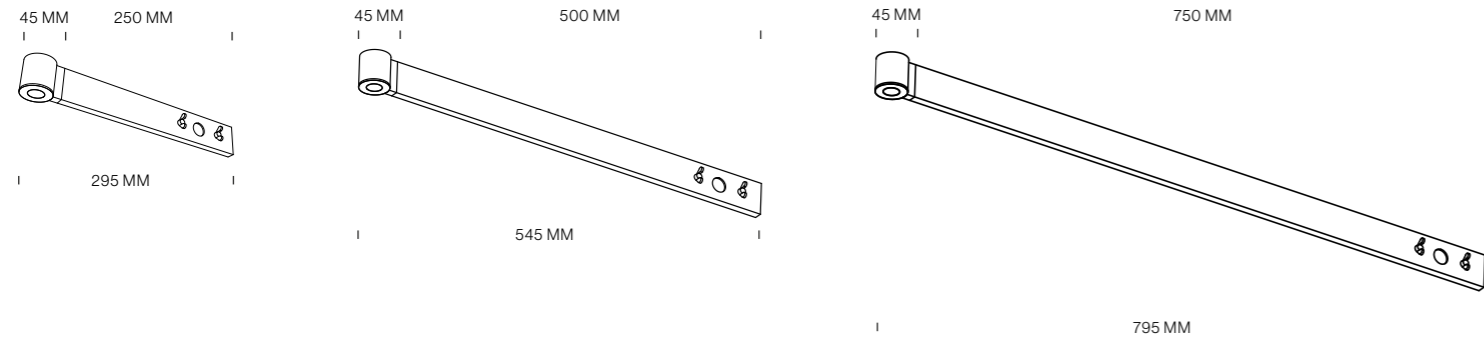

ARMS 2 SPOTS

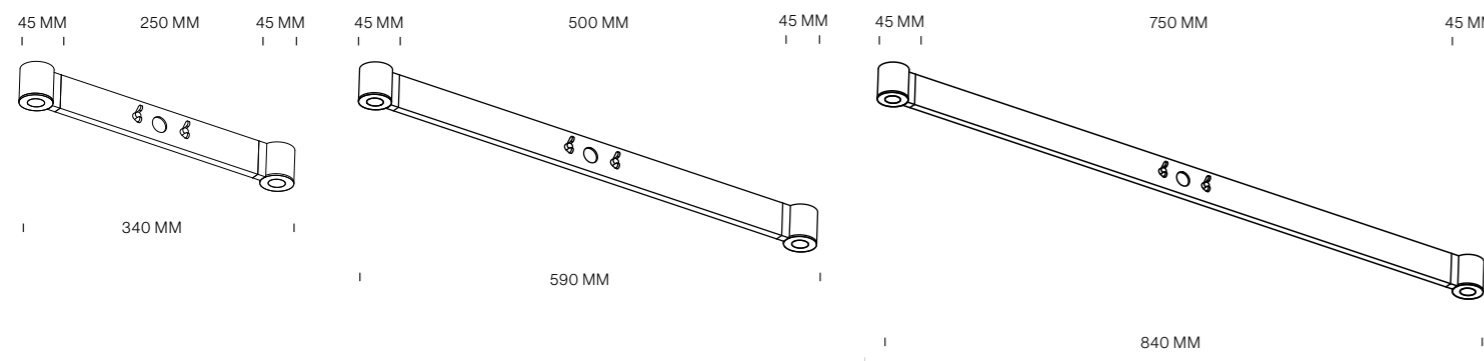

CONNECTION PIECES

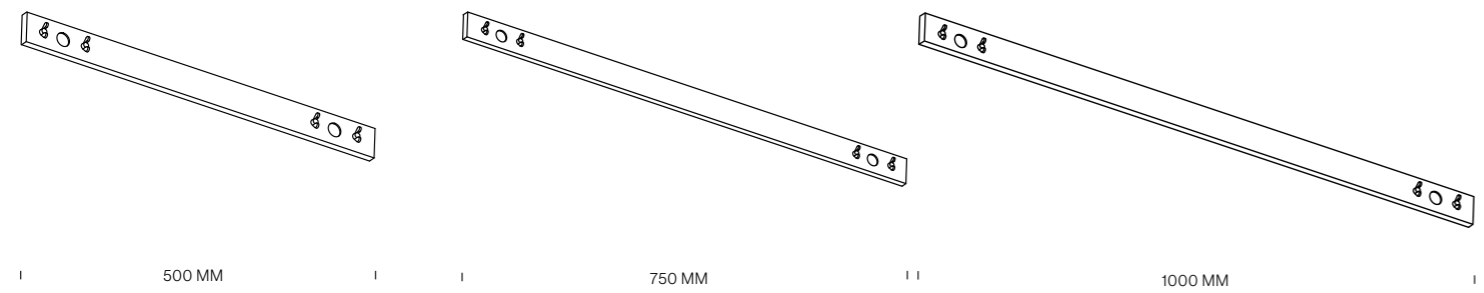

BASE WITH DRIVER

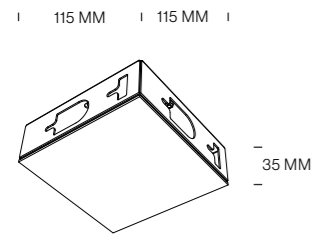

EXAMPLES - HOW TO ORDER

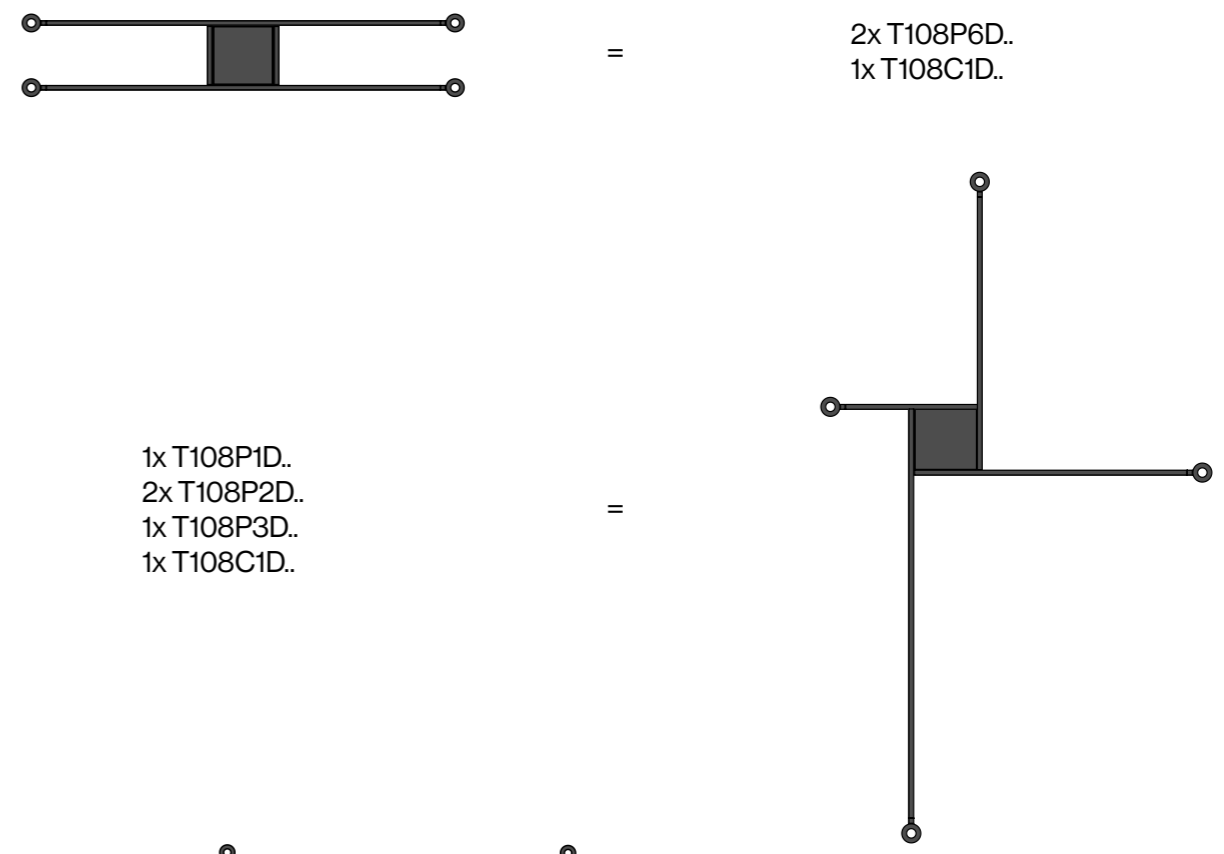

2x T108P6D..
 1x T108C1D..

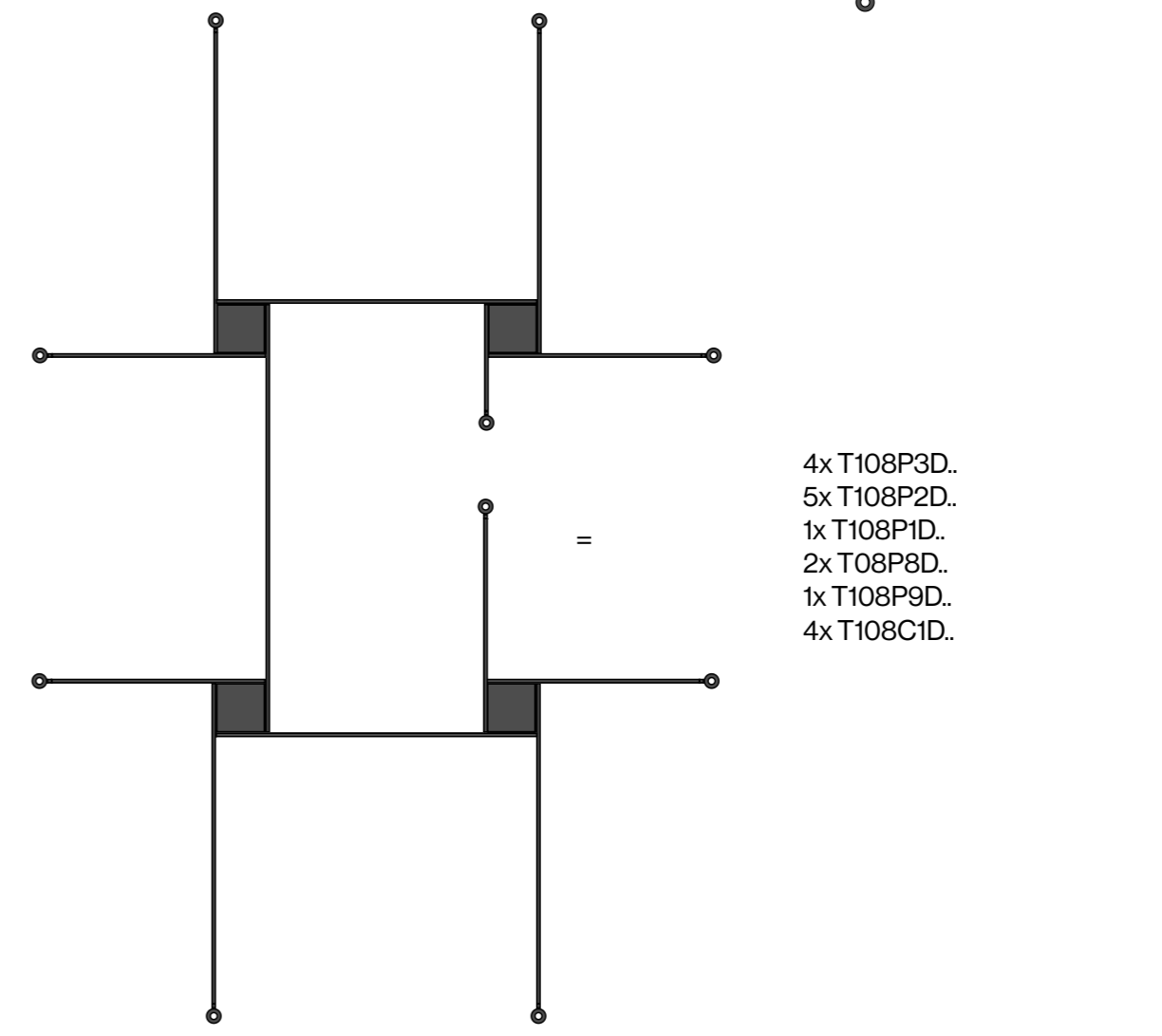

tossB

TOSSB.COM

CREATORS OF LIGHTING UNITS

INEDIT Lighting Studio 25, rue de Cléry 75002 PARIS

T. 33 (0)1 47 00 76 76 contact@inedit-lighting.com www.inedit-lighting.com