



## MINI IP20

INDOOR - INTERNO - INNENBEREICH - INTERIEUR - INTÉRIEUR - INTERIOR

Fix (not adjustable) 0° - 0°

102x238 mm

Material : CALCYT® plaster

### REMOTE LED DRIVER ON/OFF

REF N° 697 00 006 8W

REF N° 697 00 015 15W

REF N° 697 00 025 25W

230V/50Hz - - current controlled  
 - - IP20 - 350mA - not dimmable

### MINI LED DIM 100 LM

REF N° 149 60 500 CRI 80 warm white 2200°K

REF N° 149 60 000 CRI 90 warm white 2700°K

REF N° 149 60 100 CRI 90 warm white 3000°K

REF N° 149 60 200 CRI 90 neutral white 4000°K

REF N° 149 60 300 royal blue

- 1W - excl. LED driver - current controlled 350 mA - - -   
 - - serial wiring - 3 Step MacAdam  
 Requires remote LED driver - 350 mA

### REMOTE LED DRIVER DIM

REF N° 697 60 006 6W 1-10V

REF N° 697 60 015 15W 1-10V

REF N° 697 30 015 15W DALI

REF N° 697 60 025 25W 1-10V DALI PUSH

REF N° 697 60 040 40W 1-10V DALI PUSH

REF N° 697 70 009 9W PHASE DIM (tr. edge)

REF N° 697 70 017 17W PHASE DIM

230V/50Hz - - current controlled  
 - - IP20 - 350mA - dimmable

### MINI LED DIM 200 LM

REF N° 149 62 500 CRI 80 warm white 2200°K

REF N° 149 62 000 CRI 90 warm white 2700°K

REF N° 149 62 100 CRI 90 warm white 3000°K

REF N° 149 62 200 CRI 90 neutral white 4000°K

REF N° 149 62 300 royal blue

- 2W - excl. LED driver - current controlled 350 mA - - -   
 - - serial wiring - 3 Step MacAdam  
 Requires remote LED driver - 350 mA

### MINI LED DIM 400 LM

REF N° 149 61 500 CRI 80 warm white 2200°K

REF N° 149 61 000 CRI 90 warm white 2700°K

REF N° 149 61 100 CRI 90 warm white 3000°K

REF N° 149 61 200 CRI 90 neutral white 4000°K

REF N° 149 61 300 royal blue

- 4W - excl. LED driver - current controlled 350 mA - - -   
 - - serial wiring - 3 Step MacAdam  
 Requires remote LED driver - 350 mA

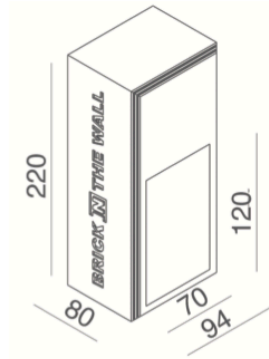

Ready for installation in solid walls  
 Optional plasterkit for installation into gypsum walls

### PLASTERKIT MINI

REF N° 749 01 000 For mounting into gypsum walls

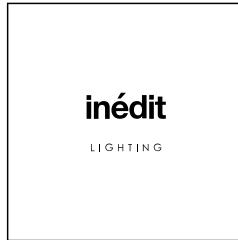

## MINI IP54

BATHROOM - STANZA DA BAGNO - BADEZIMMER - BADKAMER - SALLE DE BAINS - CUARTO DE BAÑO

Fix (not adjustable) 0° - 0°

102x238 mm

Material : CALCYT® plaster

### REMOTE LED DRIVER ON/OFF

REF N° 697 00 006 8W

REF N° 697 00 015 15W

REF N° 697 00 025 25W

230V/50Hz - - current controlled

- - IP20 - 350mA - not dimmable

### MINI LED DIM 100 LM

REF N° 149 60 501 CRI 80 warm white 2200°K

REF N° 149 60 001 CRI 90 warm white 2700°K

REF N° 149 60 101 CRI 90 warm white 3000°K

REF N° 149 60 201 CRI 90 neutral white 4000°K

REF N° 149 60 301 royal blue

- 1W - excl. LED driver - current controlled 350 mA - - - -

- - serial wiring - 3 Step MacAdam  
Requires remote LED driver - 350 mA

### REMOTE LED DRIVER DIM

REF N° 697 60 006 6W 1-10V

REF N° 697 60 015 15W 1-10V

REF N° 697 30 015 15W DALI

REF N° 697 60 025 25W 1-10V DALIPUSH

REF N° 697 60 040 40W 1-10V DALIPUSH

REF N° 697 70 009 9W PHASE DIM (tr. edge)

REF N° 697 70 017 17W PHASE DIM

230V/50Hz - - current controlled

- - IP20 - 350mA - dimmable

### MINI LED DIM 200 LM

REF N° 149 62 501 CRI 80 warm white 2200°K

REF N° 149 62 001 CRI 90 warm white 2700°K

REF N° 149 62 101 CRI 90 warm white 3000°K

REF N° 149 62 201 CRI 90 neutral white 4000°K

REF N° 149 62 301 royal blue

- 2W - excl. LED driver - current controlled 350 mA - - - -

- - serial wiring - 3 Step MacAdam  
Requires remote LED driver - 350 mA

### MINI LED DIM 400 LM

REF N° 149 61 501 CRI 80 warm white 2200°K

REF N° 149 61 001 CRI 90 warm white 2700°K

REF N° 149 61 101 CRI 90 warm white 3000°K

REF N° 149 61 201 CRI 90 neutral white 4000°K

REF N° 149 61 301 royal blue

- 4W - excl. LED driver - current controlled 350 mA - - - -

- - serial wiring - 3 Step MacAdam  
Requires remote LED driver - 350 mA

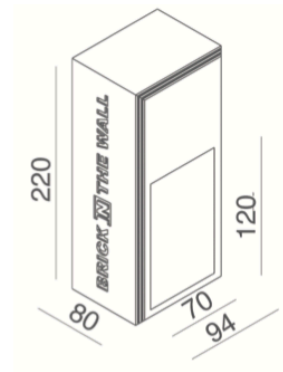

Ready for installation in solid walls  
Optional plasterkit for installation into gypsum walls

**PLASTERKIT MINI**  
REF N° 749 01 000 For mounting into gypsum walls

**inédit**

LIGHTING

## MINI SQUARE IP20

INDOOR - INTERNO - INNENBEREICH - INTERIEUR - INTÉRIEUR - INTERIOR

Fix (not adjustable) 0° - 0°

102x190 mm



Material : CALCYT® plaster

### REMOTE LED DRIVER ON/OFF

REF N° 697 00 006 8W

REF N° 697 00 015 15W

REF N° 697 00 025 25W

230V/50Hz -  - current controlled  
 -  - IP20 - 350mA - not dimmable

### MINI SQUARE LED DIM 100 LM







REF N° 150 60 500 CRI 80 warm white 2200°K

REF N° 150 60 000 CRI 90 warm white 2700°K

REF N° 150 60 100 CRI 90 warm white 3000°K

REF N° 150 60 200 CRI 90 neutral white 4000°K

REF N° 150 60 300 royal blue

 - 1W - excl. LED driver - current controlled 350 mA -  -  -  -   
 -  - serial wiring - 3 Step MacAdam  
Requires remote LED driver - 350 mA

### REMOTE LED DRIVER DIM

REF N° 697 60 006 6W 1-10V

REF N° 697 60 015 15W 1-10V

REF N° 697 30 015 15W DALI

REF N° 697 60 025 25W 1-10V DALI PUSH

REF N° 697 60 040 40W 1-10V DALI PUSH

REF N° 697 70 009 9W PHASE DIM (tr. edge)

REF N° 697 70 017 17W PHASE DIM

230V/50Hz -  - current controlled  
 -  - IP20 - 350mA - dimmable

### MINI SQUARE LED DIM 200 LM







REF N° 150 62 500 CRI 80 warm white 2200°K

REF N° 150 62 000 CRI 90 warm white 2700°K

REF N° 150 62 100 CRI 90 warm white 3000°K

REF N° 150 62 200 CRI 90 neutral white 4000°K

REF N° 150 62 300 royal blue

 - 2W - excl. LED driver - current controlled 350 mA -  -  -  -   
 -  - serial wiring - 3 Step MacAdam  
Requires remote LED driver - 350 mA

### MINI SQUARE LED DIM 400 LM







REF N° 150 61 500 CRI 80 warm white 2200°K

REF N° 150 61 000 CRI 90 warm white 2700°K

REF N° 150 61 100 CRI 90 warm white 3000°K

REF N° 150 61 200 CRI 90 neutral white 4000°K

REF N° 150 61 300 royal blue

 - 4W - excl. LED driver - current controlled 350 mA -  -  -  -   
 -  - serial wiring - 3 Step MacAdam  
Requires remote LED driver - 350 mA

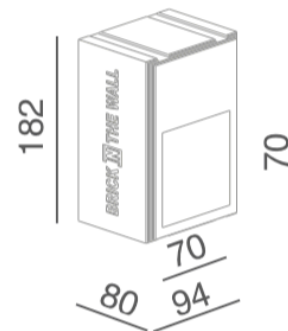

Ready for installation in solid walls  
Optional plasterkit for installation into gypsum walls

### PLASTERKIT MINI SQUARE

REF N° 750 01 000 For mounting into gypsum walls

## MINI SQUARE IP54

OUTDOOR - ESTERNO - AUßENBEREICH - EXTERIEUR - EXTÉRIEUR - EXTERIOR

Fix (not adjustable) 0° - 0°

102x190 mm

Material : waterproof CALCYT+®

### REMOTE LED DRIVER ON/OFF

REF N° 697 00 006 8W

REF N° 697 00 015 15W

REF N° 697 00 025 25W

230V/50Hz -  - current controlled

 -  - IP20 - 350mA - not dimmable

### MINI SQUARE LED DIM 100 LM

REF N° 150 60 505 CRI 80 warm white 2200°K

REF N° 150 60 005 CRI 90 warm white 2700°K

REF N° 150 60 105 CRI 90 warm white 3000°K

REF N° 150 60 205 CRI 90 neutral white 4000°K

REF N° 150 60 305 royal blue

 - 1W - excl. LED driver - current controlled 350 mA -  -  - 

 -  - serial wiring - 3 Step MacAdam  
Requires remote LED driver - 350 mA

### REMOTE LED DRIVER DIM

REF N° 697 60 006 6W 1-10V

REF N° 697 60 015 15W 1-10V

REF N° 697 30 015 15W DALI



REF N° 697 60 025 25W 1-10V DALI PUSH

REF N° 697 60 040 40W 1-10V DALI PUSH

REF N° 697 70 009 9W PHASE DIM (tr. edge)

REF N° 697 70 017 17W PHASE DIM

230V/50Hz -  - current controlled

 -  - IP20 - 350mA - dimmable

### MINI SQUARE LED DIM 200 LM

REF N° 150 62 505 CRI 80 warm white 2200°K



REF N° 150 62 005 CRI 90 warm white 2700°K

REF N° 150 62 105 CRI 90 warm white 3000°K

REF N° 150 62 205 CRI 90 neutral white 4000°K

REF N° 150 62 305 royal blue

 - 2W - excl. LED driver - current controlled 350 mA -  -  - 

 -  - serial wiring - 3 Step MacAdam  
Requires remote LED driver - 350 mA

### MINI SQUARE LED DIM 400 LM





REF N° 150 61 505 CRI 80 warm white 2200°K



REF N° 150 61 005 CRI 90 warm white 2700°K

REF N° 150 61 105 CRI 90 warm white 3000°K

REF N° 150 61 205 CRI 90 neutral white 4000°K

REF N° 150 61 305 royal blue

 - 4W - excl. LED driver - current controlled 350 mA -  -  - 

 -  - serial wiring - 3 Step MacAdam  
Requires remote LED driver - 350 mA

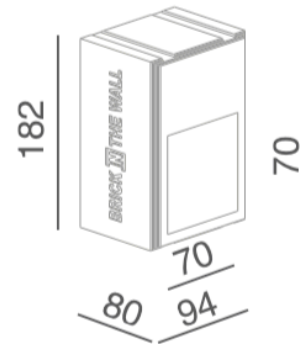

Ready for installation in solid walls  
Optional plasterkit for installation into gypsum walls

**PLASTERKIT MINI SQUARE**  
REF N° 750 01 000 For mounting into gypsum walls